

Flachdach/ Dunstrohr/ Belüftung und Entlüftung

Art.-Nr.	DN 70		DN 100			DN 125					
	KF 6040	KF 6041	KF 6050	KF 6051	KF 6052	KF 6060	KF 6061	KF 6062	KF 6070	KF 6071	KF 6072
Anschluss für Dachbahn	PVC-Anschluss	Bitumen -Anschluss	PVC-Anschluss	Bitumen -Anschluss	Klemm -Anschluss	PVC-Anschluss	Bitumen -Anschluss	Klemm -Anschluss	PVC-Anschluss	Bitumen -Anschluss	Klemm -Anschluss
Lüftungsquerschnitt	38,00 cm ²	38,00 cm ²	78,50 cm ²	78,50 cm ²	78,50 cm ²	78,50 cm ²	78,50 cm ²	78,50 cm ²	113,00 cm ²	113,00 cm ²	113,00 cm ²
Oberrohrverlängerung	---	---	---	---	---	3	3	3	1 2	1 2	1 2
O B E R T E I L											

Sanierungslüfter für Rohre ohne Muffe $\phi 100$ mm kein Unterteil notwendig.

Art.-Nr.	DN 70		DN 100		DN 125	
	KF 6500	KF 6501	KF 6510	KF 6511	KF 6520	KF 6521
Anschluss für Dachbahn	PVC-Anschluss	Bitumen -Anschluss	PVC-Anschluss	Bitumen -Anschluss	PVC-Anschluss	Bitumen -Anschluss
Lüftungsquerschnitt	38,00 cm ²	38,00 cm ²	78,50 cm ²	78,50 cm ²	113,00 cm ²	113,00 cm ²
Verlängerung bei Dämmung notwendig ab	194 mm (KF 6806)	194 mm (KF 6806)	275 mm (KE 8006)	275 mm (KE 8006)	235 mm (KF 6808)	235 mm (KF 6808)
U N T E R T E I L						

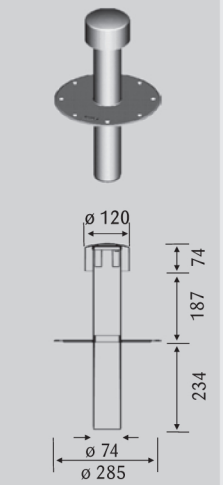
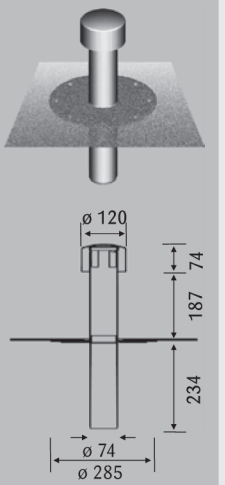
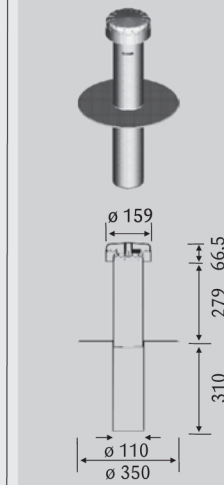
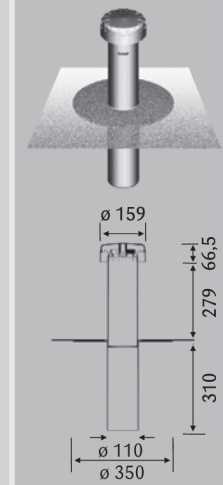
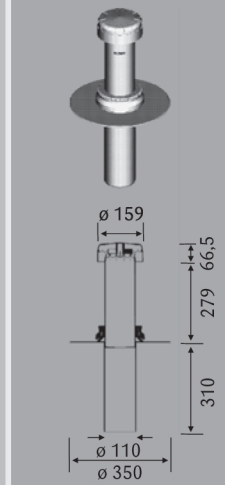
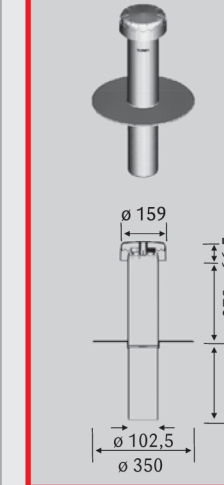
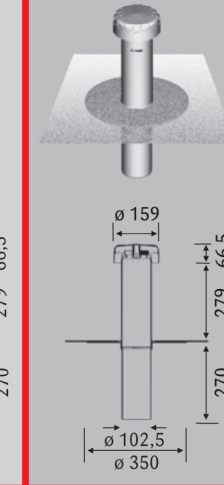
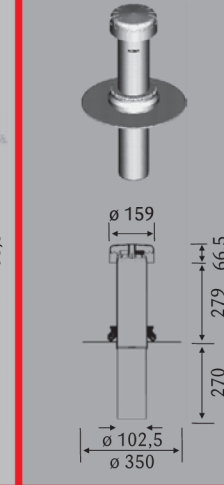
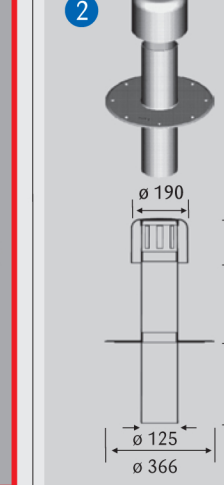
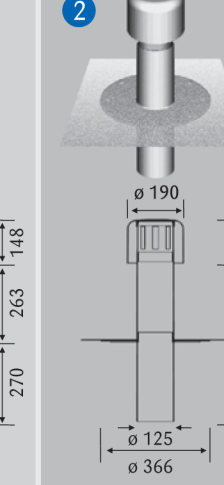
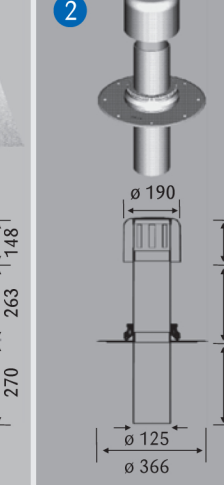
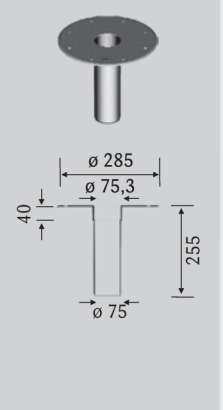
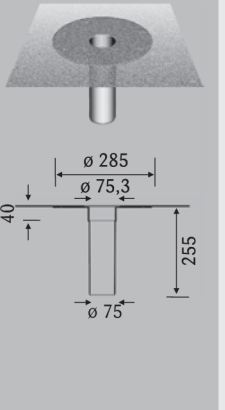
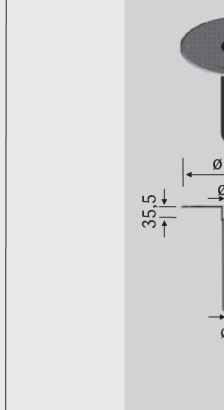
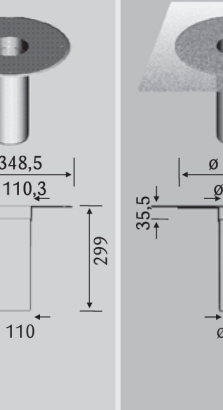
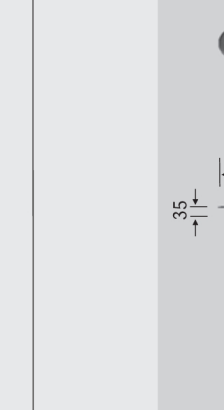
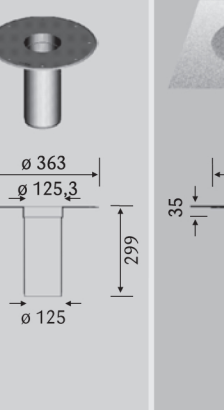
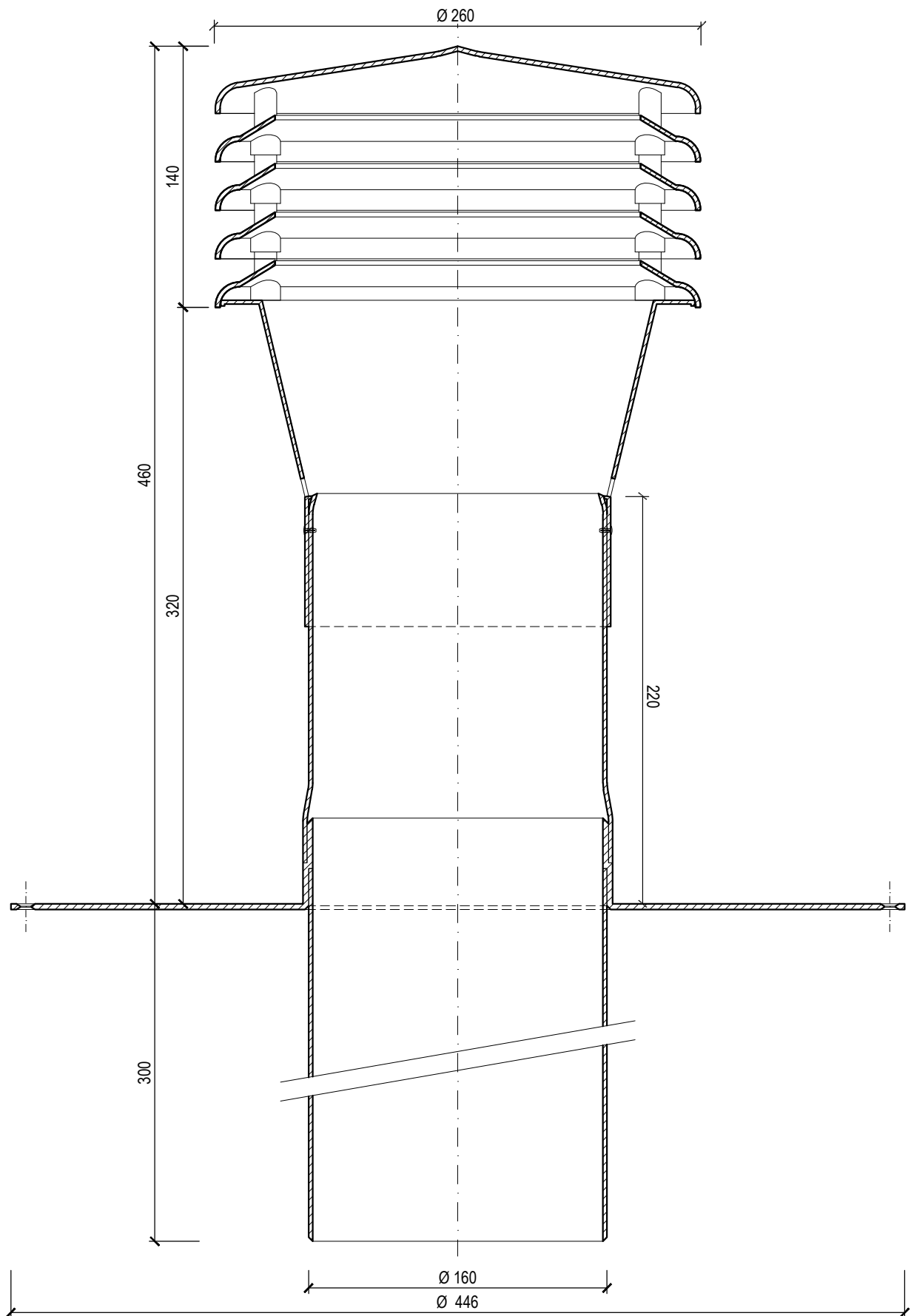

KF 6080 Flavent® Wohnraum Be- und Entlüfter DN 150 mit Hart-PVC-Flansch

Technische Änderungen vorbehalten 05/15. Für Druckfehler wird keine Haftung übernommen. ® Eingetragenes Warenzeichen der Klöber GmbH.

KLÖBER

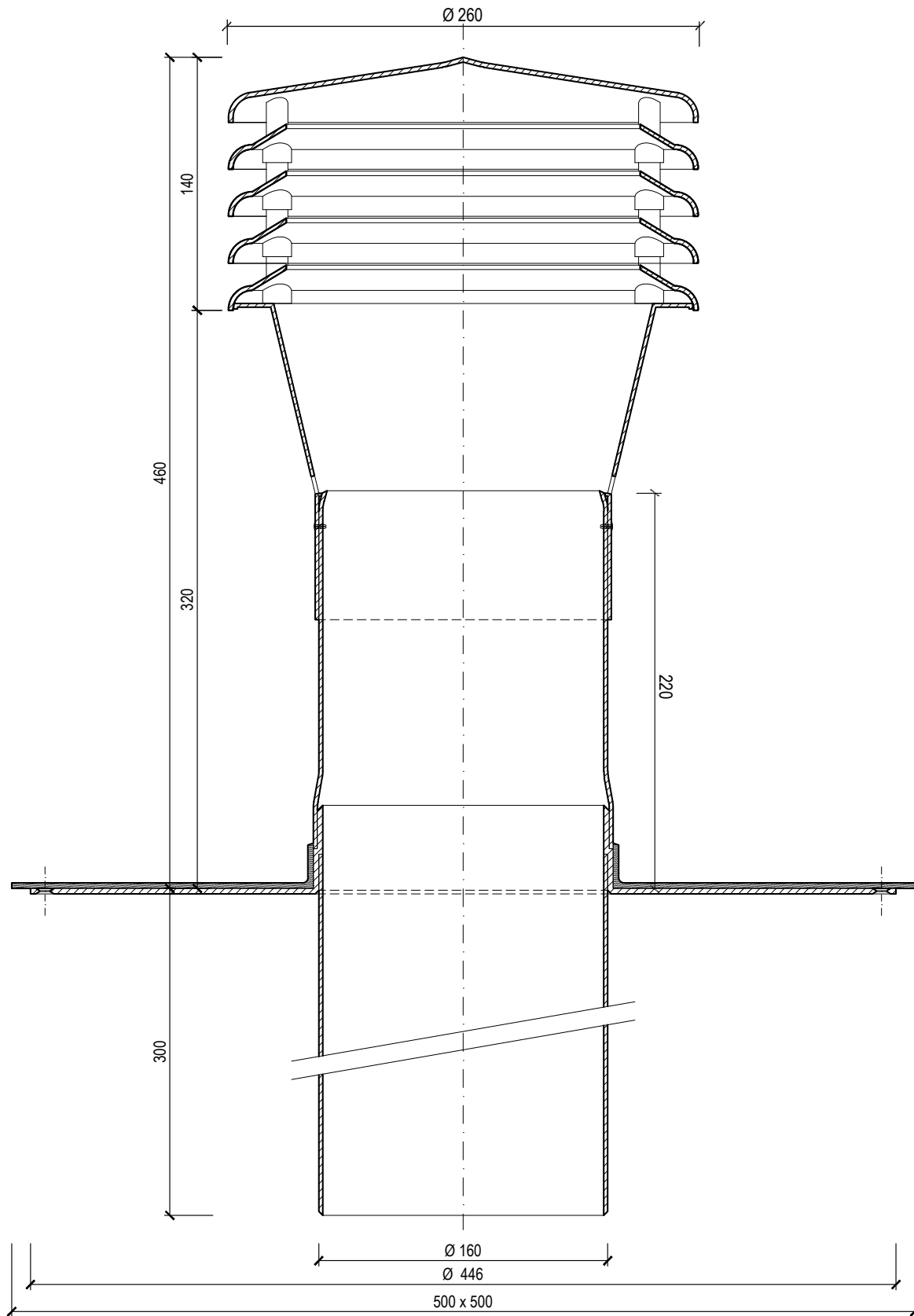

KF 6081 Flavent® Wohnraum Be- und Entlüfter DN 150 mit Bitumen-Manschette

Technische Änderungen vorbehalten 05/15. Für Druckfehler wird keine Haftung übernommen. ® Eingetragenes Warenzeichen der Klöber GmbH.

KLÖBER